

# 300 FT<sup>2</sup> HYBRID SQUARE FREEFALL CANOPY

## HYTA 300-P1

PARACHUTE INDONESIA

Jl. Gading Griya Lestari Raya Blok H1 no. 43  
Kel. Sukapura, Kec. Cilincing  
Jakarta Utara 14140, DKI Jakarta,  
Indonesia

NAMA PARASUT : FREEFALL SERIES PARACHUTE INDONESIA

DRAWN BY ARGOP

CHECKED BY R. ADIMURSITO, M.Eng, CA

APPROVED BY R. ADIMURSITO, M.Eng, CA

UKURAN DALAM SATUAN MILIMETER

TANGGAL GAMBAR 1 JANUARI 2023

TIDAK UNTUK DI SKALA

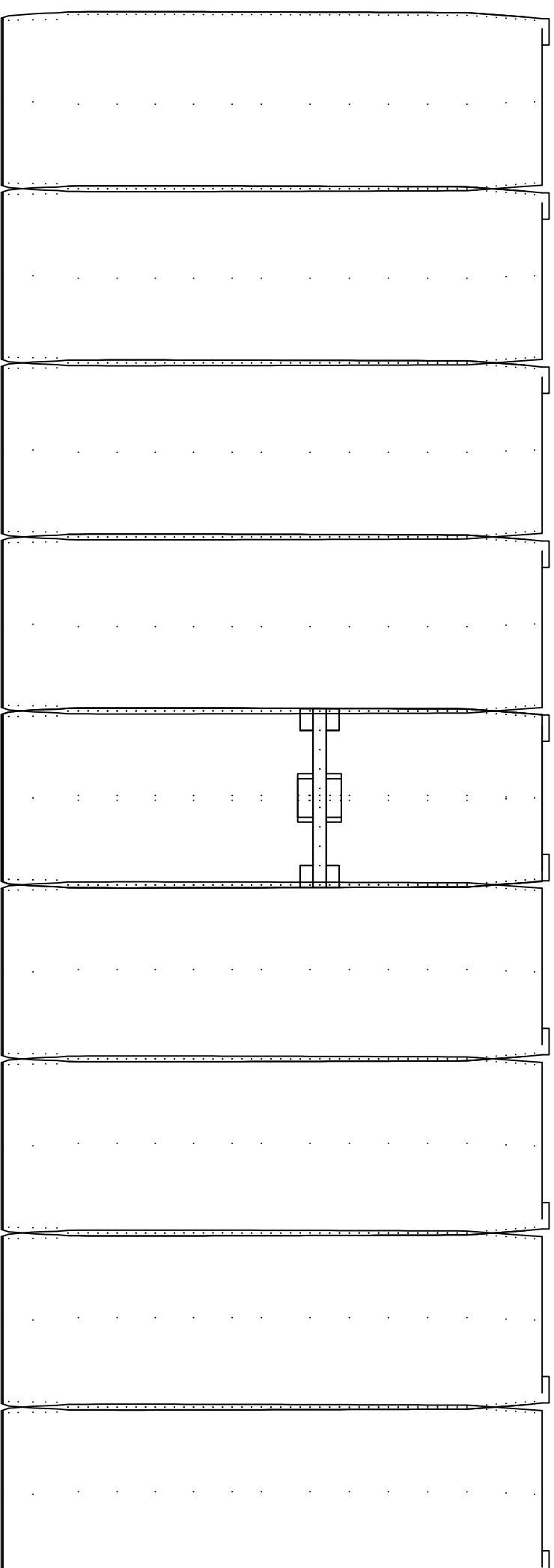

HYSQ SERIES 300  
NO OF CELLS: 9  
PARACHUTE TYPE: SQUARE  
CHORD LENGTH: 3082.74 MM  
WINGSPAN: 9041.00 MM  
PROJECTED WINGSPAN: 8085.77 MM  
ASPECT RATIO: 1:2.93

HYTA SERIES  
PARACHUTE MATERIALS OVERVIEW  
MAIN FABRIC: ZERO POROSITY RIPSTOP  
NYLON AND MIL-C-44378 T1  
SUSPENSION AND CONTROL LINE:  
POLYESTER DACRON LINE-600 LBS  
POLYESTER DACRON LINE-900 LBS

## PARACHUTE INDONESIA

Jl. Gading Griya Lestari Raya Blok H1 no. 43  
Kel. Sukapura, Kec. Cilincing  
Jakarta Utara 14140, DKI Jakarta,  
Indonesia

## OVERVIEW SEL ATAS

NAMA PARASUT FREEFALL SQUARE P1	DRAWN BY	ARGO.P
UKURAN PARASUT 280 SQFT	CHECKED BY	R. ADMURSTO, M.Eng, CA
JENIS MATERIAL UTAMA ZP RIPSTOP NYLON	APPROVED BY	R. ADMURSTO, M.Eng, CA
UKURAN DALAM MILIMETER	TANGGAL GAMBAR	30 DESEMBER 2022
TIDAK UNTUK DI SKALA		

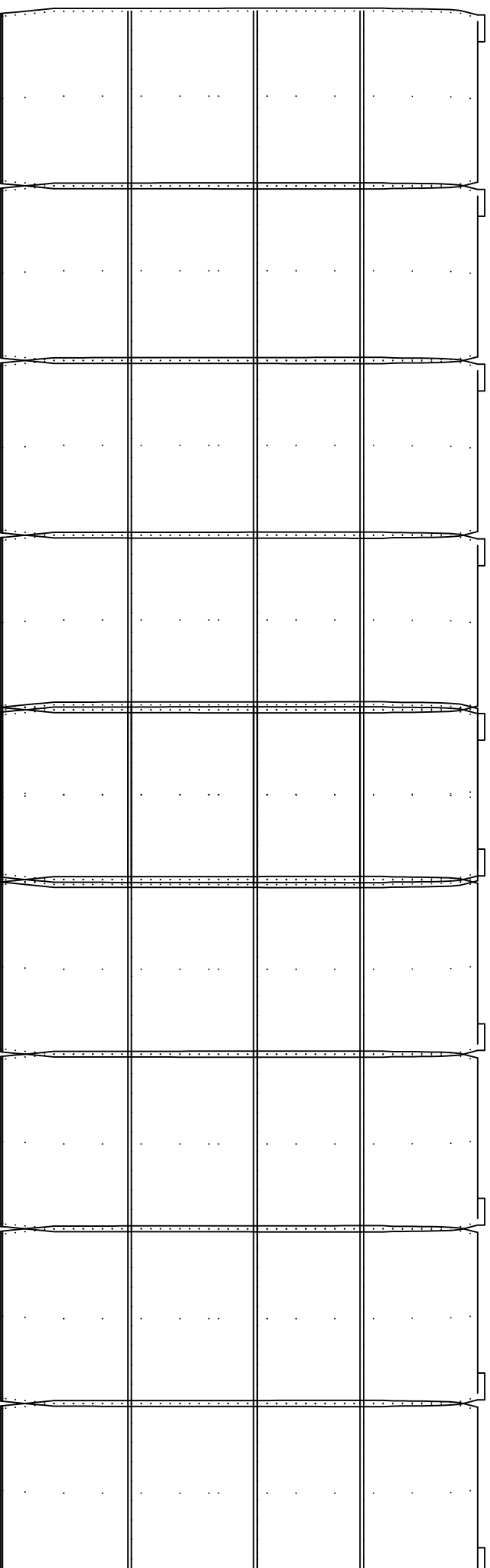

HYSQ SERIES 300  
NO OF CELLS: 9  
PARACHUTE TYPE: SQUARE  
CHORD LENGTH: 3082.74 MM  
WINGSPAN: 9041.00 MM  
PROJECTED WINGSPAN: 8085.77 MM  
ASPECT RATIO: 1:2.93

HYTA SERIES  
PARACHUTE MATERIALS OVERVIEW  
MAIN FABRIC: ZERO POROSITY RIPSTOP  
NYLON AND MIL-C-44378 T1  
SUSPENSION AND CONTROL LINE:  
POLYESTER DACRON LINE-600 LBS  
POLYESTER DACRON LINE-900 LBS

## PARACHUTE INDONESIA

Jl. Gading Griya Lestari Raya Blok H1 no. 43  
Kel. Sukapura, Kec. Cilincing  
Jakarta Utara 14140, DKI Jakarta,  
Indonesia

## OVERVIEW SEL ATAS

NAMA PARASUT FREEFALL SQUARE PI	DRAWN BY	ARGO.P
UKURAN PARASUT 300 SQFT	CHECKED BY	R. ADMURSTO, M.Eng, CA
JENIS MATERIAL UTAMA ZP RIPSTOP NYLON	APPROVED BY	R. ADMURSTO, M.Eng, CA
UKURAN DALAM MILIMETER	TANGGAL GAMBAR	30 DESEMBER 2022
TIDAK UNTUK DI SKALA		

# DIMENSI

PARACHUTE INDONESIA

Jl. Gading Griya Lestari Raya Blok H1 no. 43  
Kel. Sukapura, Kec. Cilincing  
Jakarta Utara 14140, DKI Jakarta,  
Indonesia

NAMA PARASUT FREEFALL SERIES PARACHUTE INDONESIA

DRAWN BY ARGOP

CHECKED BY

R. ADIMURSITO, M.Eng, CA

UKURAN DALAM SATUAN MILIMETER

APPROVED BY R. ADIMURSITO, M.Eng, CA

TIDAK UNTUK DI SKALA

TANGGAL GAMBAR 1 JANUARI 2023

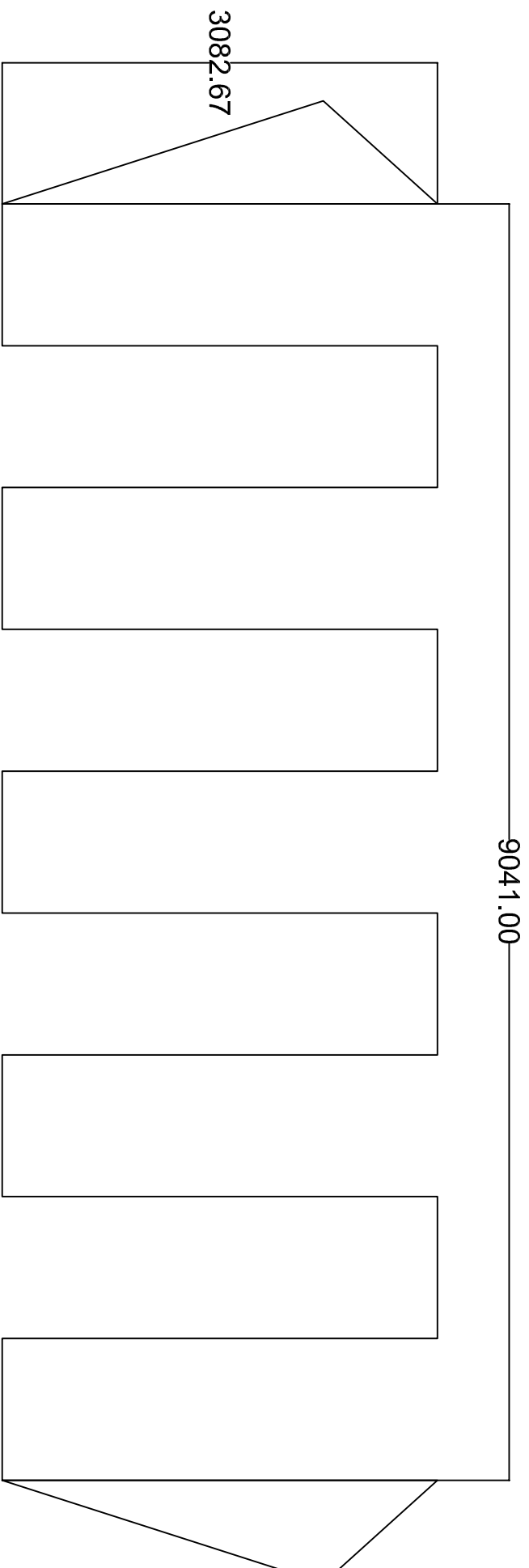

HYSQ SERIES 300  
NO OF CELLS: 9  
PARACHUTE TYPE: SQUARE  
CHORD LENGTH: 3082.74 MM  
WINGSPAN: 9041.00 MM  
PROJECTED WINGSPAN: 8085.77 MM  
ASPECT RATIO: 1:2.93

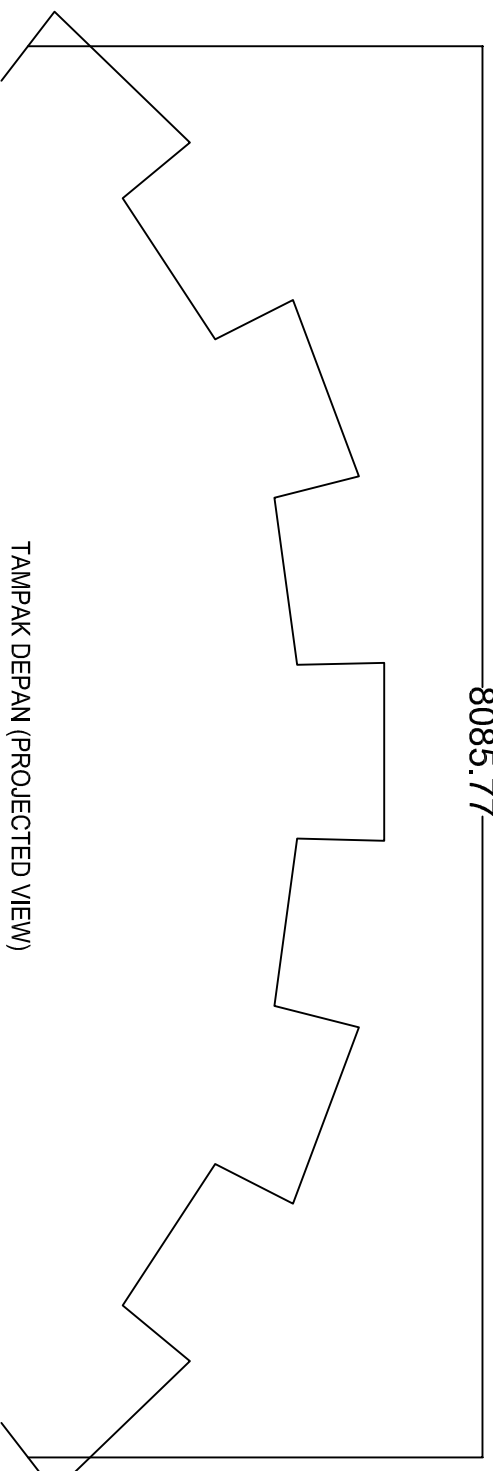

PARACHUTE INDONESIA

DIMENSI KANOPI SQ 280 PI

Jl. Gading Griya Lestari Raya Blok HI no. 43  
Kel. Sukapura, Kec. Cilincing  
Jakarta Utara 14140, DKI Jakarta,  
Indonesia

NAMA PARASUT FREEFALL SQUARE PI	DRAWN BY	ARGO,P
UKURAN PARASUT 300 SQFT	CHECKED BY	R. ADMURSITO, M.Eng, CA
JENIS MATERIAL UTAMA ZP RIPSTOP NYLON	APPROVED BY	R. ADMURSITO, M.Eng, CA
UKURAN DALAM MILIMETER	TANGGAL GAMBAR	30 DESEMBER 2022
TIDAK UNTUK DI SKALA		

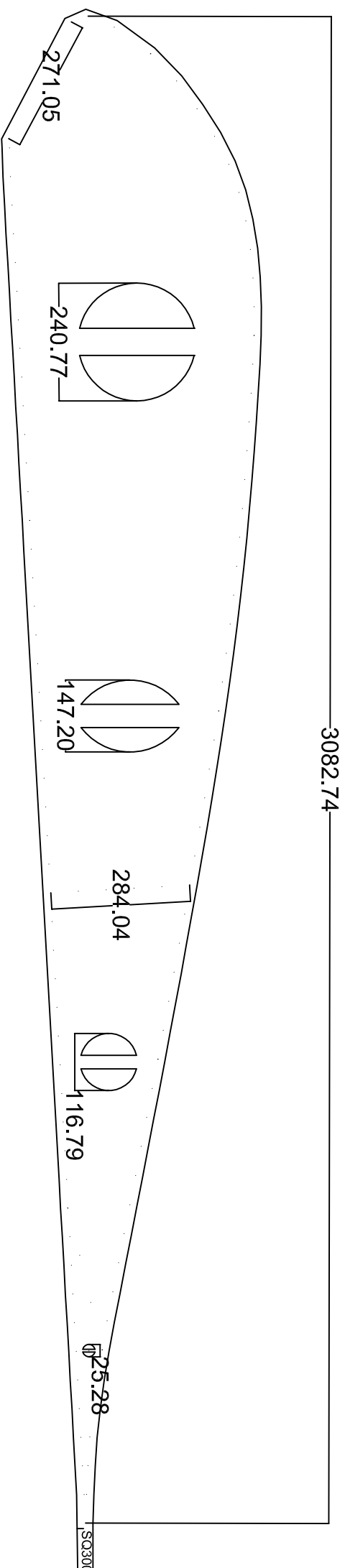

PARACHUTE INDONESIA

Jl. Gading Griya Lestari Raya Blok H1 no. 43  
 Kel. Sukapura, Kec. Cilincing  
 Jakarta Utara 14140, DKI Jakarta,  
 Indonesia

RIB CENTER

NAMA PARASUT FREEFALL SQUARE P1	DRAWN BY	ARGO,P
UKURAN PARASUT 300 SQFT	CHECKED BY	R. ADIMURSITO, M.Eng, CA
JENIS MATERIAL UTAMA ZP RIPSTOP NYLON	APPROVED BY	R. ADIMURSITO, M.Eng, CA
UKURAN DALAM SATUAN MILIMETER	TANGGAL GAMBAR	30 DESEMBER 2022
TIDAK UNTUK DI SKALA		

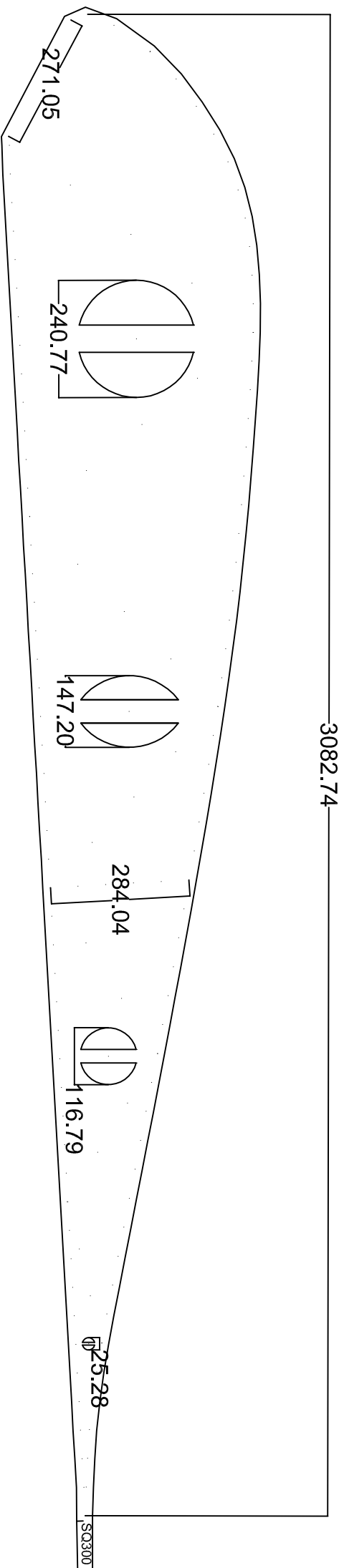

3082.74

PARACHUTE INDONESIA

Jl. Gading Griya Lestari Raya Blok H1 no. 43  
 Kel. Sukapura, Kec. Cilincing  
 Jakarta Utara 14140, DKI Jakarta,  
 Indonesia

RIBS 2

NAMA PARASUT FREEFALL SQUARE P1		DRAWN BY		ARGO.P
UKURAN PARASUT 300 SQFT		CHECKED BY		R. ADIMURSITO, M.Eng, CA
JENIS MATERIAL UTAMA ZP RIPSTOP NYLON		APPROVED BY		R. ADIMURSITO, M.Eng, CA
UKURAN DALAM SATUAN MILIMETER		TANGGAL GAMBAR		30 DESEMBER 2022
TIDAK UNTUK DI SKALA				

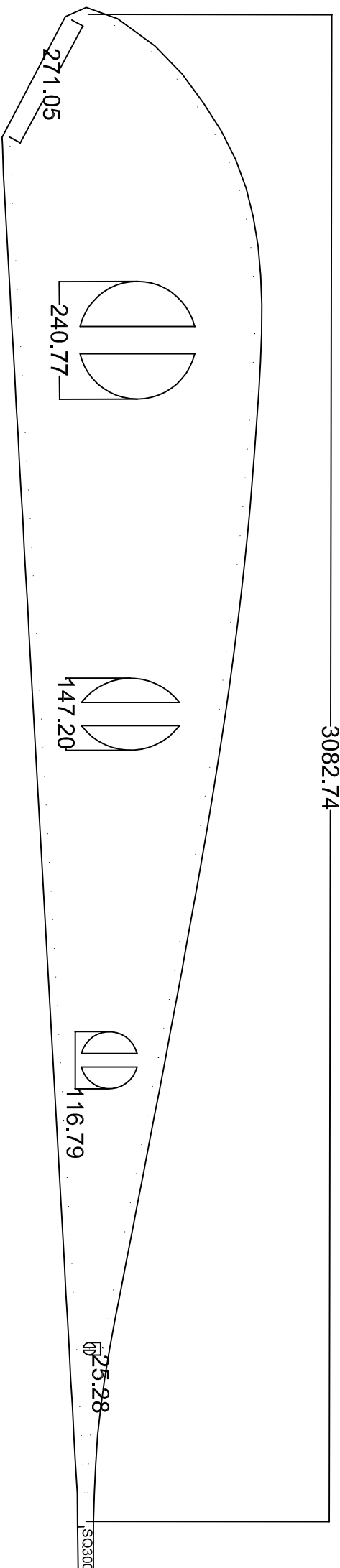

PARACHUTE INDONESIA

RIBS 3,5,7,9

Jl. Gading Griya Lestari Raya Blok H1 no. 43  
 Kel. Sukapura, Kec. Cilincing  
 Jakarta Utara 14140, DKI Jakarta,  
 Indonesia

NAMA PARASUT FREEFALL SQUARE P1	DRAWN BY	ARGO,P
UKURAN PARASUT 300 SQFT	CHECKED BY	R. ADIMURSITO, M.Eng, CA
JENIS MATERIAL UTAMA ZP RIPSTOP NYLON	APPROVED BY	R. ADIMURSITO, M.Eng, CA
UKURAN DALAM SATUAN MILIMETER	TANGGAL GAMBAR	30 DESEMBER 2022
TIDAK UNTUK DI SKALA		



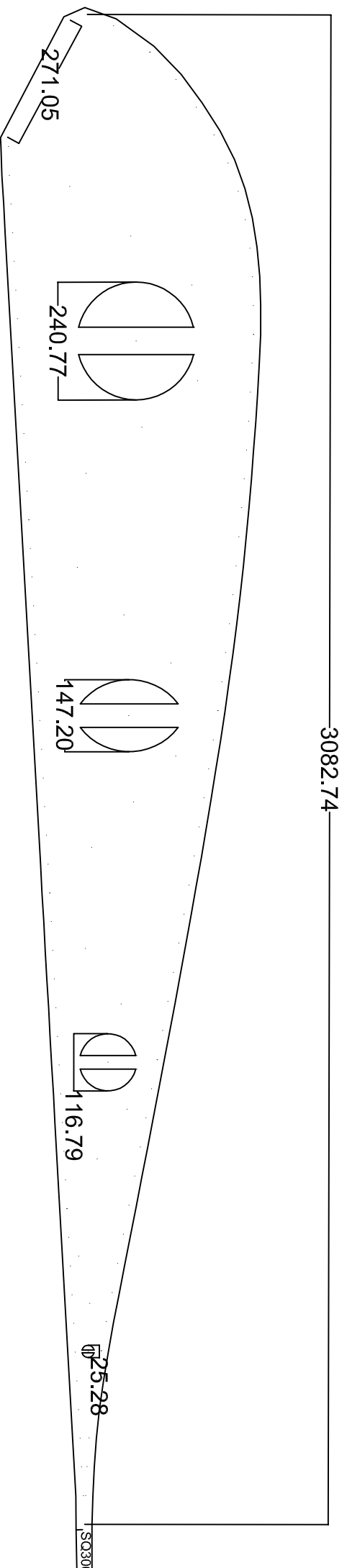

PARACHUTE INDONESIA

RIBS 4,6,8

Jl. Gading Griya Lestari Raya Blok H1 no. 43  
 Kel. Sukapura, Kec. Cilincing  
 Jakarta Utara 14140, DKI Jakarta,  
 Indonesia

NAMA PARASUT FREEFALL SQUARE P1		DRAWN BY		ARGO,P
UKURAN PARASUT 300 SQFT		CHECKED BY		R. ADIMURSITO, M.Eng, CA
JENIS MATERIAL UTAMA ZP RIPSTOP NYLON		APPROVED BY		R. ADIMURSITO, M.Eng, CA
UKURAN DALAM SATUAN MILIMETER		TANGGAL GAMBAR		30 DESEMBER 2022
TIDAK UNTUK DI SKALA				

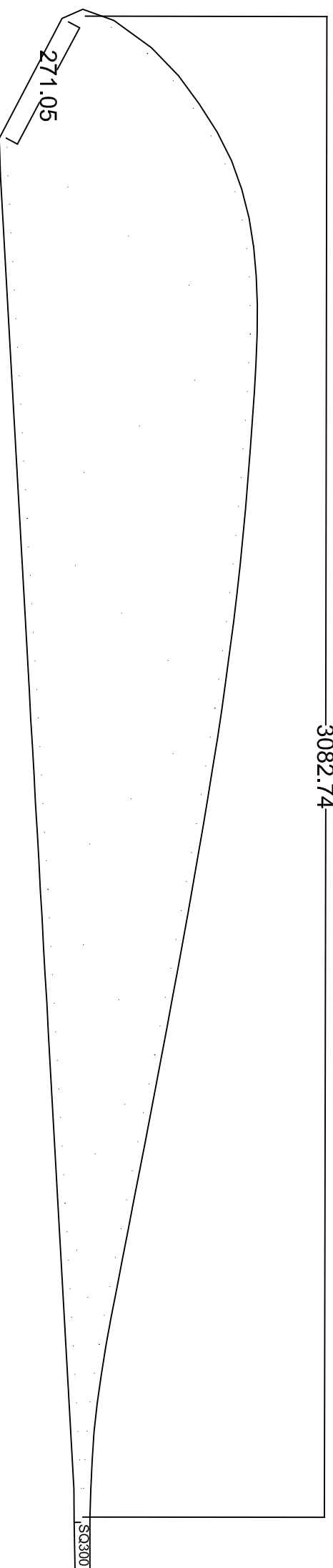

PARACHUTE INDONESIA

Jl. Gading Griya Lestari Raya Blok H1 no. 43  
Kel. Sukapura, Kec. Cilincing  
Jakarta Utara 14140, DKI Jakarta,  
Indonesia

RIBS 10

NAMA PARASUT FREEFALL SQUARE P1	DRAWN BY	ARGO,P
UKURAN PARASUT 300 SQFT	CHECKED BY	R. ADIMURSITO, M.Eng, CA
JENIS MATERIAL UTAMA ZP RIPSTOP NYLON	APPROVED BY	R. ADIMURSITO, M.Eng, CA
UKURAN DALAM SATUAN MILIMETER	TANGGAL GAMBAR	30 DESEMBER 2022
TIDAK UNTUK DI SKALA		

3277.84

1953.77

1324.07

ASQ300

PARACHUTE INDONESIA

Jl. Gading Griya Lestari Raya Blok H1 no. 43  
Kel. Sukapura, Kec. Cilincing  
Jakarta Utara 14140, DKI Jakarta,  
Indonesia

SEL ATAS CENTER

NAMA PARASUT FREEFALL SQUARE PI	DRAWN BY	ARGO,P
UKURAN PARASUT 300 SQFT	CHECKED BY	R. ADMURSITO, M.Eng, CA
JENIS MATERIAL UTAMA ZP RIPSTOP NYLON	APPROVED BY	R. ADMURSITO, M.Eng, CA
UKURAN DALAM SATUAN MILIMETER	TANGGAL GAMBAR	30 DESEMBER 2022
TIDAK UNTUK DI SKALA		

3277.84

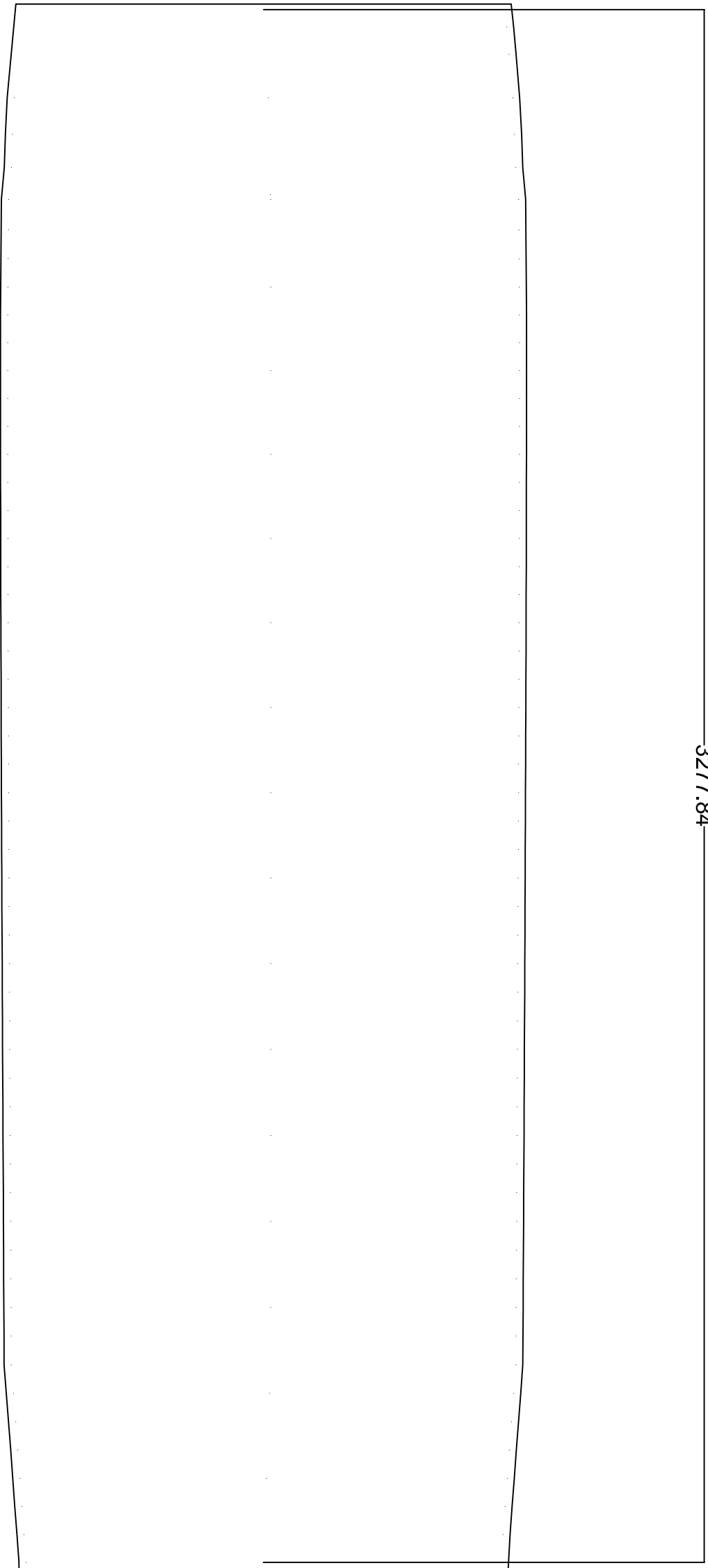

ASQ300

**PARACHUTE INDONESIA**

Jl. Gading Griya Lestari Raya Blok H1 no. 43  
Kel. Sukapura, Kec. Cilincing  
Jakarta Utara 14140, DKI Jakarta,  
Indonesia

**SEL ATAS**

NAMA PARASUT FREEFALL SQUARE PI	DRAWN BY	ARGO,P
UKURAN PARASUT 300 SQFT	CHECKED BY	R. ADIMURSITO, M.Eng, CA
JENIS MATERIAL UTAMA ZP RIPSTOP NYLON	APPROVED BY	R. ADIMURSITO, M.Eng, CA
UKURAN DALAM SATUAN MILIMETER	TANGGAL GAMBAR	30 DESEMBER 2022
TIDAK UNTUK DI SKALA		

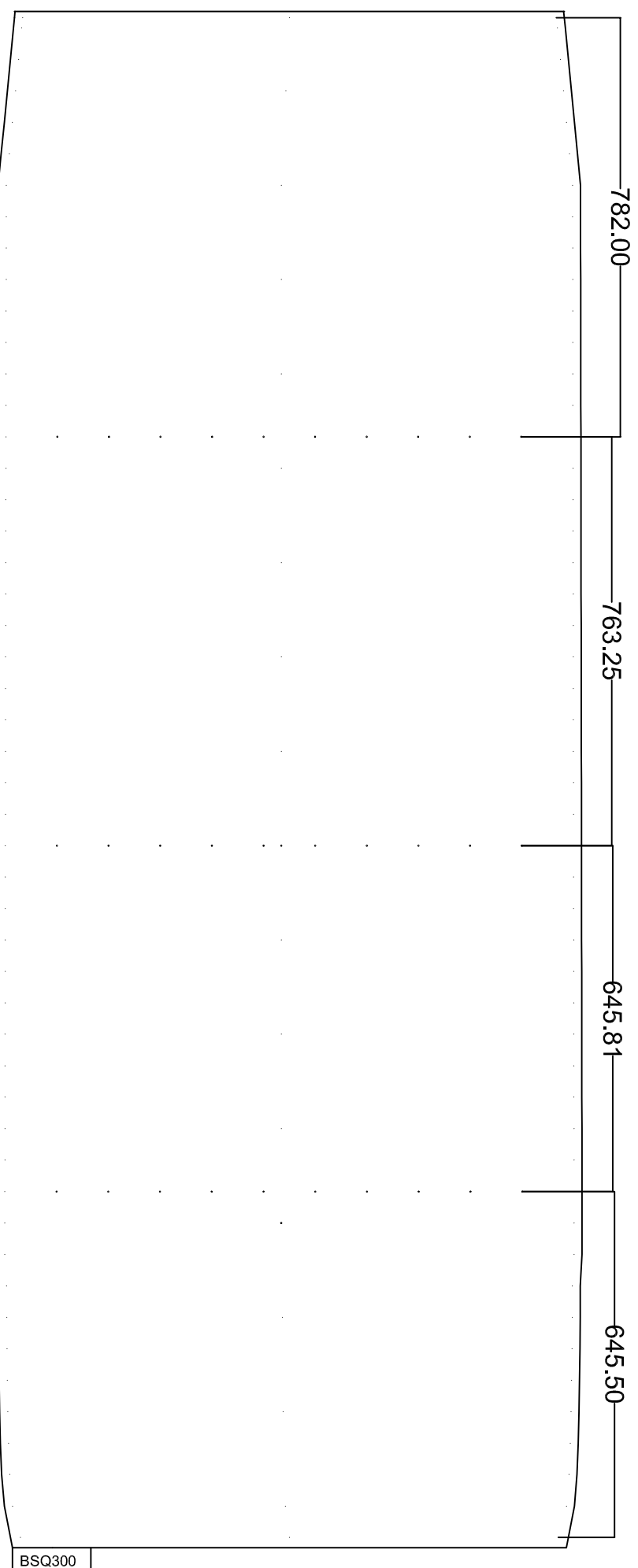

PARACHUTE INDONESIA

Jl. Gading Griya Lestari Raya Blok H1 no. 43  
 Kel. Sukapura, Kec. Cilincing  
 Jakarta Utara 14140, DKI Jakarta,  
 Indonesia

SEL BAWAH

NAMA PARASUT FREEFALL SQUARE P1	DRAWN BY	ARGO,P
UKURAN PARASUT 300 SQFT	CHECKED BY	R. ADIMURSITO, M.Eng, CA
JENIS MATERIAL UTAMA ZP RIPSTOP NYLON	APPROVED BY	R. ADIMURSITO, M.Eng, CA
UKURAN DALAM SATUAN MILIMETER	TANGGAL GAMBAR	30 DESEMBER 2022
TIDAK UNTUK DI SKALA		

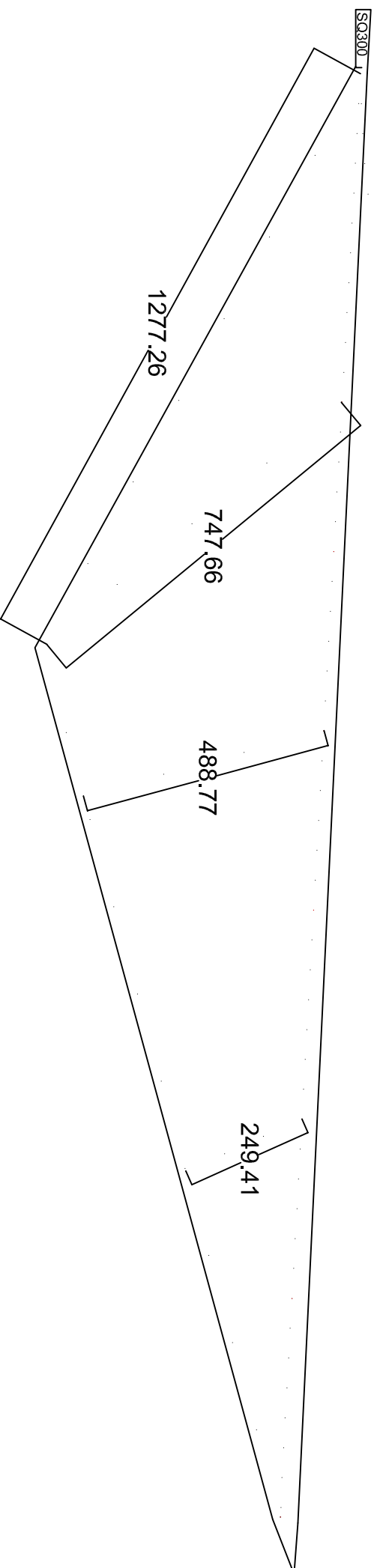

**PARACHUTE INDONESIA**

Jl. Gading Griya Lestari Raya Blok H1 no. 43  
 Kel. Sukapura, Kec. Cilincing  
 Jakarta Utara 14140, DKI Jakarta,  
 Indonesia

**STABILIZER**

NAMA PARASUT FREEFALL SQUARE PI	DRAWN BY	ARGO,P
UKURAN PARASUT 300 SQFT	CHECKED BY	R. ADIMURSITO, M.Eng, CA
JENIS MATERIAL UTAMA ZP RIPSTOP NYLON	APPROVED BY	R. ADIMURSITO, M.Eng, CA
UKURAN DALAM SATUAN MILIMETER	TANGGAL GAMBAR	30 DESEMBER 2022
TIDAK UNTUK DI SKALA		

# MAL TALI SQ300-PI

## UKURAN TALI PROGRAM FREEFALL SQUARE 300

RISER A	RISER B
Joint Line A1	Joint Line
Line A11	Line B11
Line A12	Line B12
Joint Line A2	Joint Line
Line A21	Line B21
Line A22	Line B22
Joint Line A3	Joint Line
Line A31	Line B31
Line A32	Line B32
Joint Line A4	Joint Line
Line A41	Line B41
Line A42	Line B41
Joint Line A5	Joint Line
Line A51	Line B51
Line A52	Line B52

TALI KEMUDI
JOINT LINE TOGGLE
TOGGLE RIBS 7
TOGGLE RIBS 8
TOGGLE RIBS 9
TOGGLE RIBS 10

### CATATAN

ukuran tali dalam Milimeter  
penomoran dimulai dari tengah parasut  
Joint line tali berada pada Line Ax1 dan Line Bx1

## PARACHUTE INDONESIA

Jl. Gading Griya Lestari Raya Blok H1 no. 43  
Kel. Sukapura, Kec. Cilincing  
Jakarta Utara 14140, DKI Jakarta,  
Indonesia

NAMA PARASUT FREEFALL SQUARE PI

DRAWN BY ARGO.P

UKURAN PARASUT 300 SQFT

CHECKED BY R. ADIMURSITO, M.Eng, CA

UKURAN DALAM SATUAN MILIMETER

TANGGAL GAMBAR 1 JANUARI 2023

TIDAK UNTUK DI SKALA



# MATERIAL

## PARACHUTE INDONESIA

Jl. Gading Griya Lestari Raya Blok H1 no. 43  
Kel. Sukapura, Kec. Cilincing  
Jakarta Utara 14140, DKI Jakarta,  
Indonesia

NAMA PARASUT FREEFALL SERIES PARACHUTE INDONESIA

DRAWN BY ARGO.P

CHECKED BY R. ADIMURSITO, M.Eng, CA

APPROVED BY R. ADIMURSITO, M.Eng, CA

UKURAN DALAM SATUAN MILIMETER

TANGGAL GAMBAR 1 JANUARI 2023

TIDAK UNTUK DI SKALA



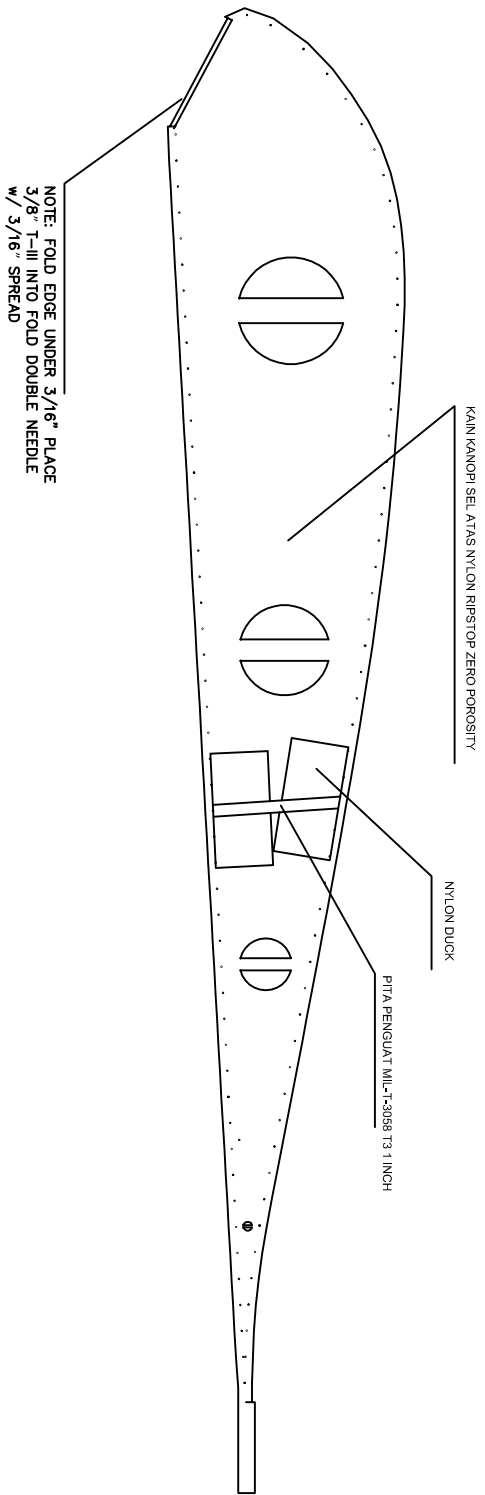

**PARACHUTE INDONESIA**

Jl. Gading Griya Lestari Raya Blok HI no. 43  
 Kel. Sukapura, Kec. Cilincing  
 Jakarta Utara 14140, DKI Jakarta,  
 Indonesia

**RIB CENTER**

NAMA PARASUT : FREEFALL SERIES PARACHUTE INDONESIA		DRAWN BY	ARGO,P
JENIS MATERIAL UTAMA ZP RIPSTOP NYLON		CHECKED BY	R. ADIMURSITO, M.Eng, CA
UKURAN DALAM SATUAN MILIMETER	TANGGAL GAMBAR 1 JANUARI 2023	APPROVED BY	R. ADIMURSITO, M.Eng, CA
TIDAK UNTUK DI SKALA			

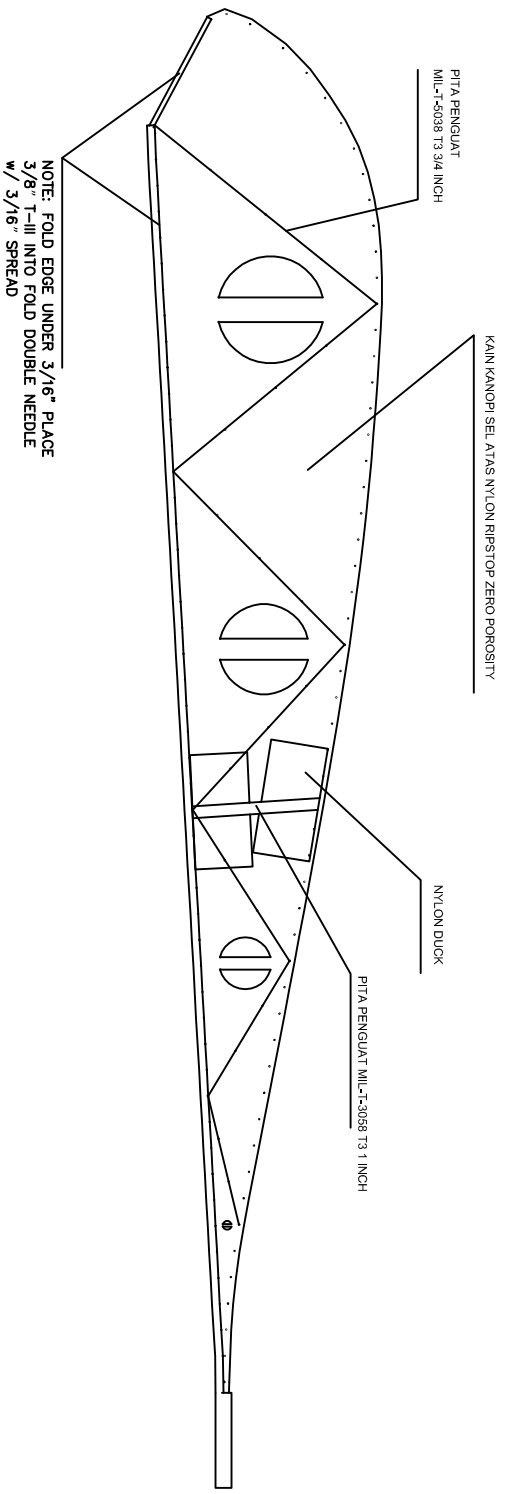

PARACHUTE INDONESIA

Jl. Gading Griya Lestari Raya Blok HI no. 43  
 Kel. Sukapura, Kec. Cilincing  
 Jakarta Utara 14140, DKI Jakarta,  
 Indonesia

RIB 2

NAMA PARASUT : FREEFALL SERIES PARACHUTE INDONESIA		DRAWN BY	ARGO,P
JENIS MATERIAL UTAMA ZP RIPSTOP NYLON		CHECKED BY	R. ADIMURSITO, M.Eng, CA
UKURAN DALAM SATUAN MILIMETER	TANGGAL GAMBAR	APPROVED BY	R. ADIMURSITO, M.Eng, CA
TIDAK UNTUK DI SKALA	1 JANUARI 2023		

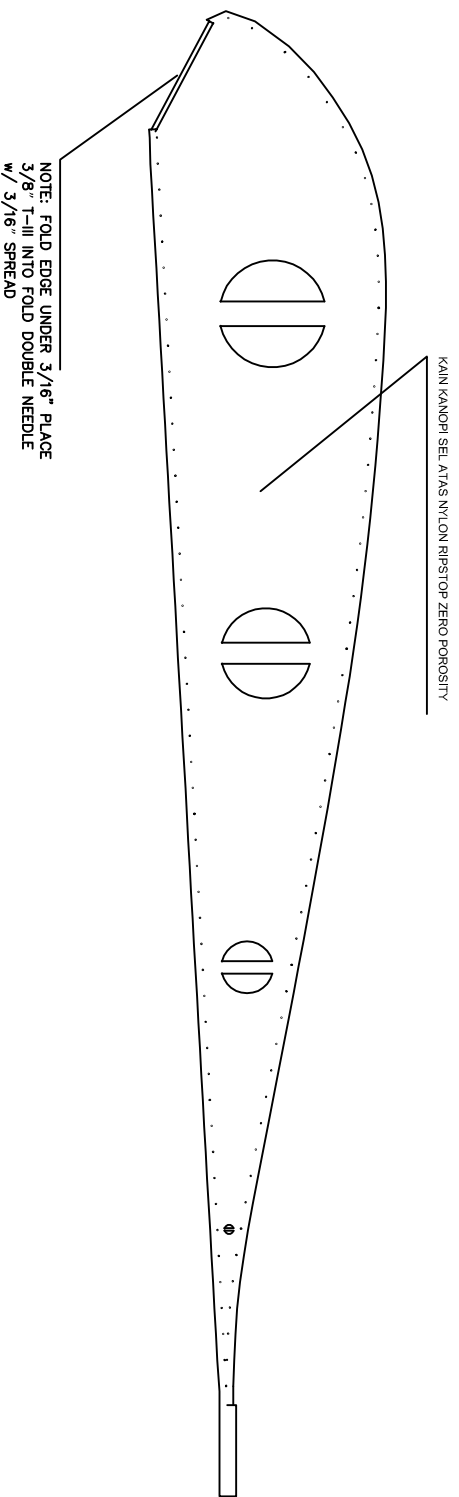

**PARACHUTE INDONESIA**

Jl. Gading Griya Lestari Raya Blok H1 no. 43  
 Kel. Sukapura, Kec. Cilincing  
 Jakarta Utara 14140, DKI Jakarta,  
 Indonesia

**RIB GANJIL**

NAMA PARASUT : FREEFALL SERIES PARACHUTE INDONESIA	DRAWN BY	ARGO,P
JENIS MATERIAL UTAMA ZP RIPSTOP NYLON	CHECKED BY	R. ADIMURSITO, M.Eng, CA
UKURAN DALAM SATUAN MILIMETER	APPROVED BY	R. ADIMURSITO, M.Eng, CA
TIDAK UNTUK DI SKALA	TANGGAL GAMBAR	1 JANUARI 2023

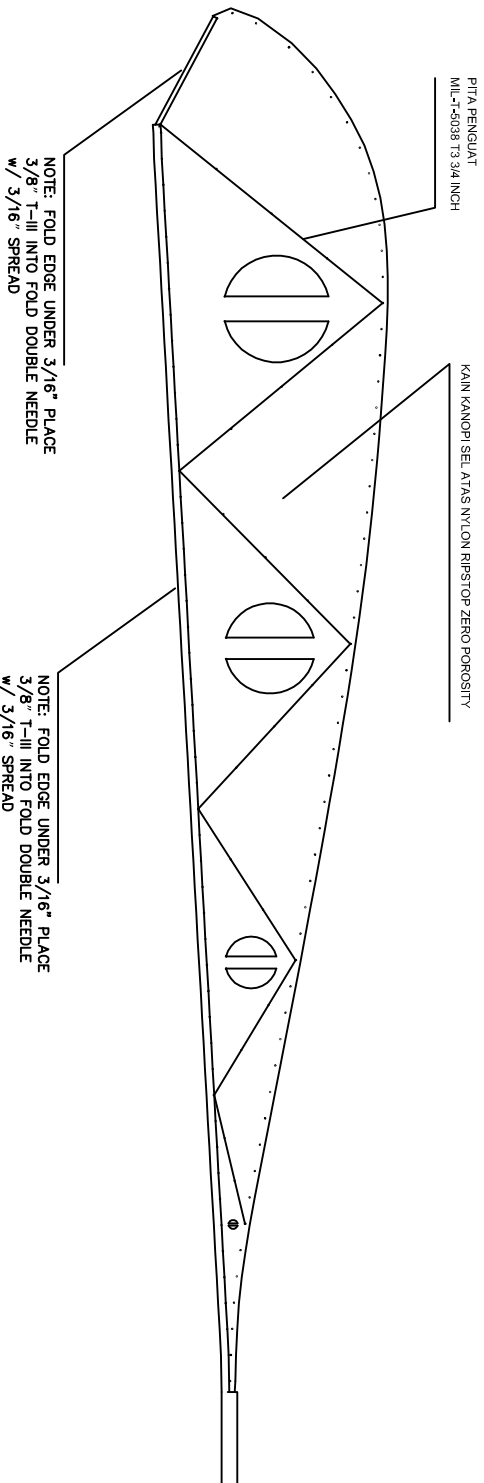

**PARACHUTE INDONESIA**

Jl. Gading Griya Lestari Raya Blok HI no. 43  
 Kel. Sukapura, Kec. Cilincing  
 Jakarta Utara 14140, DKI Jakarta,  
 Indonesia

**RIB GENAP**

NAMA PARASUT : FREEFALL SERIES PARACHUTE INDONESIA	DRAWN BY	ARGO.P
JENIS MATERIAL UTAMA ZP RIPSTOP NYLON	CHECKED BY	R. ADIMURSITO, M.Eng, CA
UKURAN DALAM SATUAN MILIMETER	APPROVED BY	R. ADIMURSITO, M.Eng, CA
TIDAK UNTUK DI SKALA	TANGGAL GAMBAR	1 JANUARI 2023

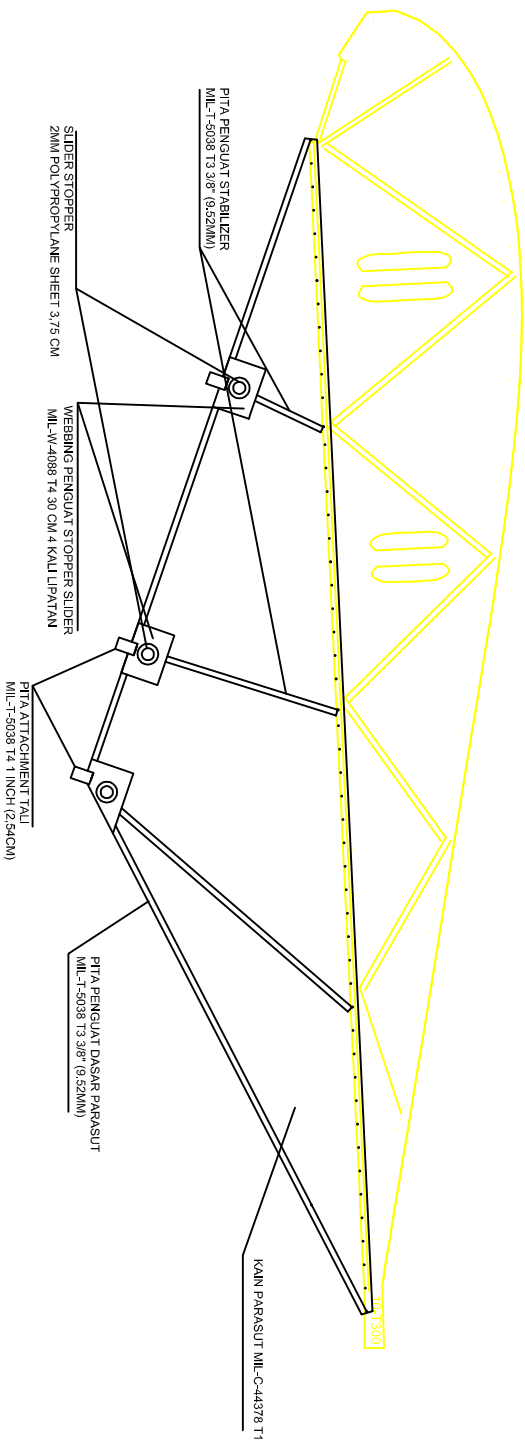

PARACHUTE INDONESIA

Jl. Gading Griya Lestari Raya Blok HI no. 43  
 Kel. Sukapura, Kec. Cilincing  
 Jakarta Utara 14140, DKI Jakarta,  
 Indonesia

STABILIZER

NAMA PARASUT : FREEFALL SERIES PARACHUTE INDONESIA	DRAWN BY	ARGO.P
JENIS MATERIAL UTAMA ZP RIPSTOP NYLON	CHECKED BY	R. ADIMURSITO, M.Eng, CA
UKURAN DALAM SATUAN MILIMETER	APPROVED BY	R. ADIMURSITO, M.Eng, CA
TIDAK UNTUK DI SKALA	TANGGAL GAMBAR	1 JANUARI 2023

Jl. Gading Griya Lestari Raya Blok HI no. 43  
Kel. Sukapura, Kec. Cilincing  
Jakarta Utara 14140, DKI Jakarta,  
Indonesia

PARACHUTE INDONESIA

SEL ATAS CENTER

NAMA PARASUT : FREEFALL SERIES PARACHUTE INDONESIA	DRAWN BY	ARGO.P
JENIS MATERIAL UTAMA ZP RIPSTOP NYLON	CHECKED BY	R. ADIMURSITO, M.Eng, CA
UKURAN DALAM SATUAN MILIMETER	APPROVED BY	R. ADIMURSITO, M.Eng, CA
TIDAK UNTUK DI SKALA	TANGGAL GAMBAR	1 JANUARI 2023

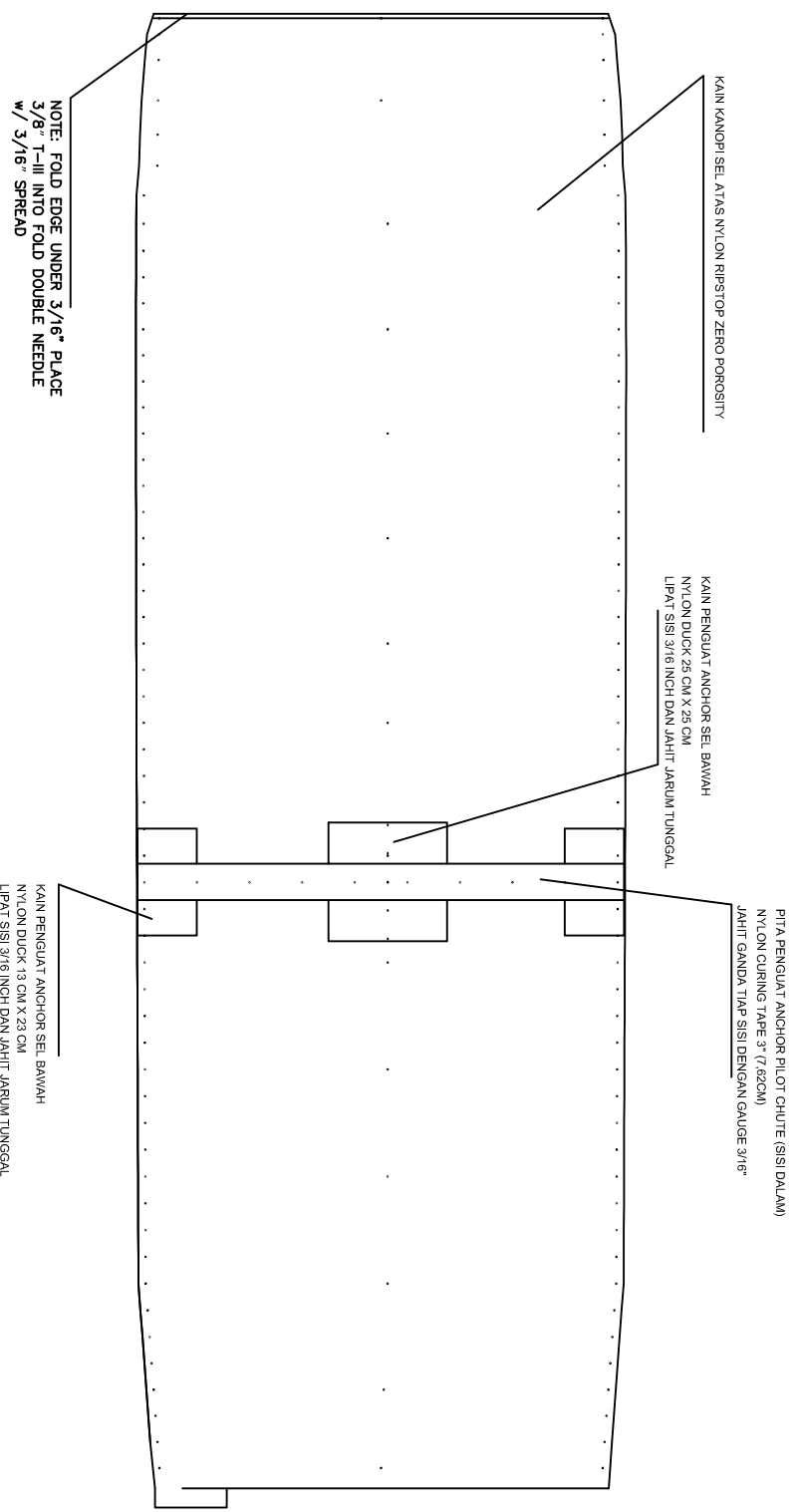

KAIN KANOPHI SEL ATAS NYLON RIPSTOP ZERO POROSITY

NOTE: FOLD EDGE UNDER 3/16" PLACE  
3/8" T-III INTO FOLD DOUBLE NEEDLE  
w/ 3/16" SPREAD

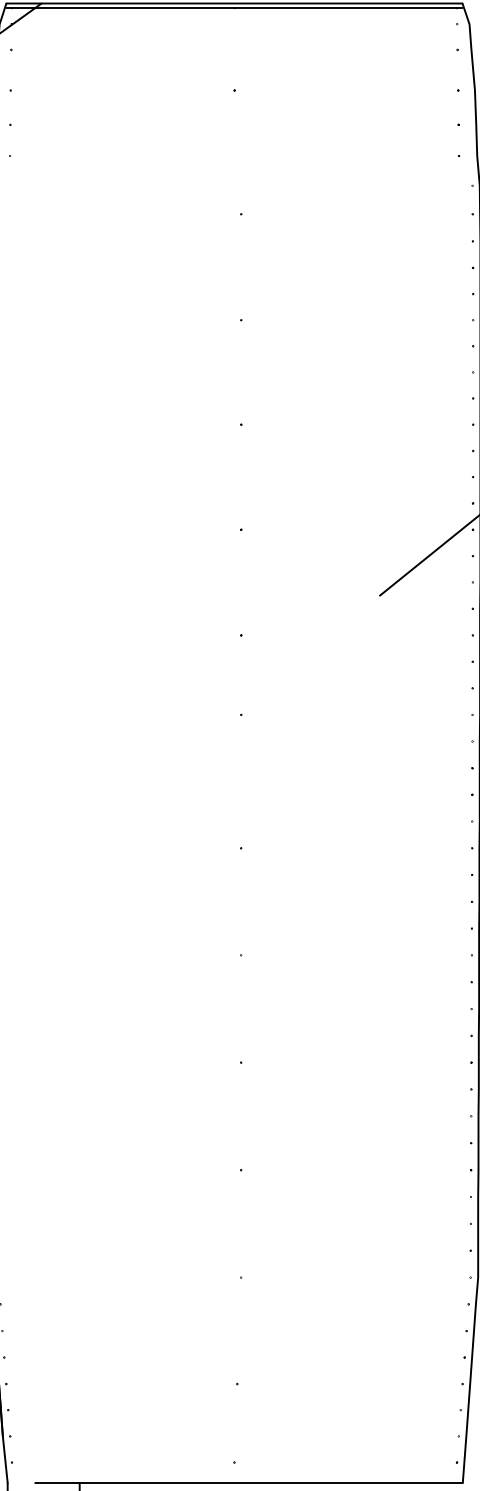

PARACHUTE INDONESIA

Jl. Gading Griya Lestari Raya Blok HI no. 43  
Kel. Sukapura, Kec. Cilincing  
Jakarta Utara 14140, DKI Jakarta,  
Indonesia

SEL ATAS

NAMA PARASUT : FREEFALL SERIES PARACHUTE INDONESIA	DRAWN BY	ARGO.P
JENIS MATERIAL UTAMA ZP RIPSTOP NYLON	CHECKED BY	R. ADIMURSITO, M.Eng, CA
UKURAN DALAM SATUAN MILIMETER	APPROVED BY	R. ADIMURSITO, M.Eng, CA
TIDAK UNTUK DI SKALA	TANGGAL GAMBAR	1 JANUARI 2023

PITA PENGUAT  
MIL-T-5038 T3 3/4 INCH

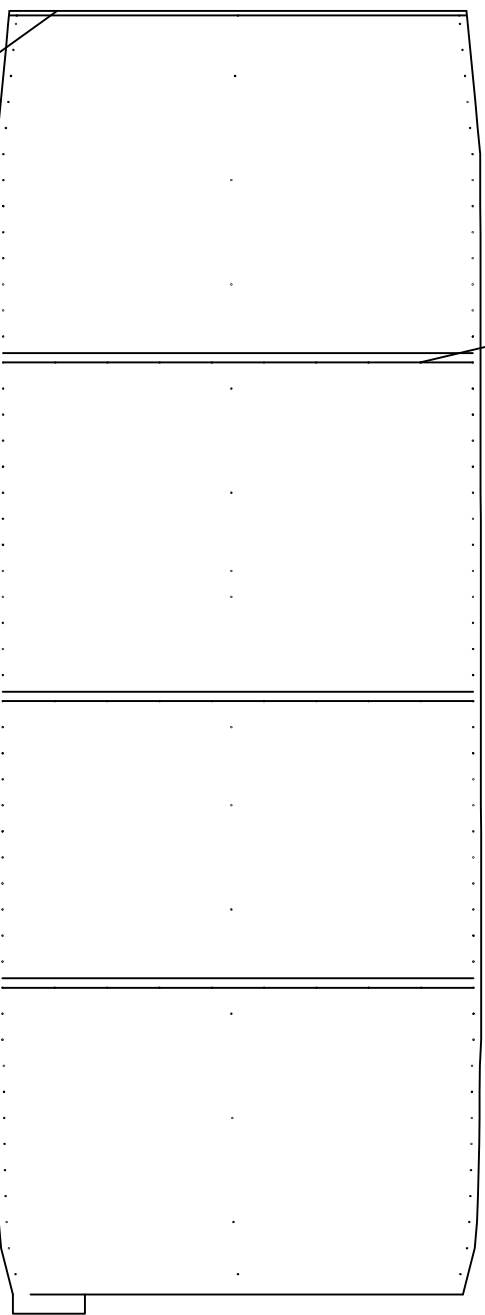

NOTE: FOLD EDGE UNDER 3/16" PLACE  
3/8" T-III INTO FOLD DOUBLE NEEDLE  
W/ 3/16" SPREAD

PARACHUTE INDONESIA

Jl. Gading Griya Lestari Raya Blok HI no. 43  
Kel. Sukapura, Kec. Cilincing  
Jakarta Utara 14140, DKI Jakarta,  
Indonesia

SEL BAWAH

NAMA PARASUT : FREEFALL SERIES PARACHUTE INDONESIA	DRAWN BY	ARGO,P
JENIS MATERIAL UTAMA: MIL-C-44378 TYPE 1 LO-PO RIPSTOP NYLON	CHECKED BY	R. ADIMURSITO, M.Eng, CA
UKURAN DALAM SATUAN MILIMETER	APPROVED BY	R. ADIMURSITO, M.Eng, CA
TIDAK UNTUK DI SKALA	TANGGAL GAMBAR	1 JANUARI 2023



# MATERIAL LIST SQ-300-P1

1. Cloth Paracute Nylon (Kain Parasut Utama)	grey/silver	MIL-C-44378 T/I (F-111)-GREY	99.69 m
2. Zero Porosity Ripstop Nylon (Silver)	Silver	COMMERCIAL	199.4 m
3. Tape Nylon 3/8"	putih	MIL-T-5038 T/III Class 1A-3/8"-PUTIH	31.85 m
4. Tape Nylon 1" - Klem tipis 2.54 cm Hijau	hijau	MIL-T-5038 T/III-1"-HIJAU	8.308 m
5. Tape Nylon 1"	putih	MIL-T-5038 T/IV-1"-PUTIH	1.385 m
6. Tape type 4 3/4 inch	putih	MIL-T-5038 TIV-3/4"-PUTIH	18 m
7. Tape Nylon 3/4"	hijau	MIL-T-5038 T/III-3/4"-HIJAU	132 m
8. Tape type 4 1.5 inch	putih	MIL-T-5038 TIV-1.5"-PUTIH	1.385 m
9. Natural Nylon Cure Tape	putih	Plain Weave 2 3/4 x 8 3/4	2.769 m
10. Tape type 3 3/4 inch	putih	MIL-T-5038 T/III 3/4"	97 m
11. Webbing Nylon 3"	putih	MIL-W-4088 T/IV-3"-PUTIH	9.692 m
12. Cloth Duck Nylon	hijau	MIL-C-7219 T/III-HIJAU	2.4 m
13. Polyester Line #3511-1000	putih	3511-1000"	5.538 m
14. Polyester Line #3511-525	putih	3511-525"	429.2 m
15. Polyester Line #3511-750	putih	3511-750"	41.54 m
16. 1 1/4 INCH PP Plastic 2mm thick		1 1/4"	6 buah
17. O.D Steel Ring 1 1/4		1 1/4"	1 buah
18. Benang VT-295e "E" Silver	gray/Silver	VT-295E	1 cones

## PARACHUTE INDONESIA

Jl. Gading Griya Lestari Raya Blok H1 no. 43  
Kel. Sukapura, Kec. Cilincing  
Jakarta Utara 14140, DKI Jakarta,  
Indonesia

NAMA PARASUT FREEFALL SQUARE P1

DRAWN BY ARGO.P

UKURAN PARASUT 300 SQFT

CHECKED BY R. ADIMURSITO, M.Eng. CA

APPROVED BY R. ADIMURSITO, M.Eng. CA

TANGGAL GAMBAR 1 JANUARI 2023

TIDAK UNTUK DI SKALA

# DETAIL PENJAHITAN

## PARACHUTE INDONESIA

Jl. Gading Griya Lestari Raya Blok H1 no. 43  
Kel. Sukapura, Kec. Cilincing  
Jakarta Utara 14140, DKI Jakarta,  
Indonesia

NAMA PARASUT FREEFALL SERIES PARACHUTE INDONESIA

DRAWN BY ARGO.P

CHECKED BY R. ADIMURSITO, M.Eng, CA

APPROVED BY R. ADIMURSITO, M.Eng, CA

UKURAN DALAM SATUAN MILIMETER

TANGGAL GAMBAR 1 JANUARI 2023

TIDAK UNTUK DI SKALA